

CROWN PROFILES

Crown moulding profiles are typically decorative mouldings designed for use along the intersection of a wall and ceiling. May be combined with other mouldings to create a "built-up" profile.

6" Crown
AZM-45

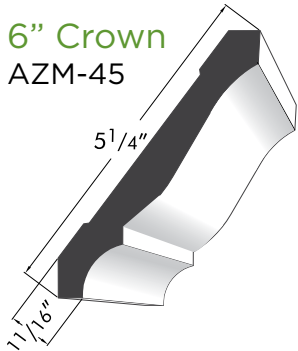

5" Crown
AZM-47

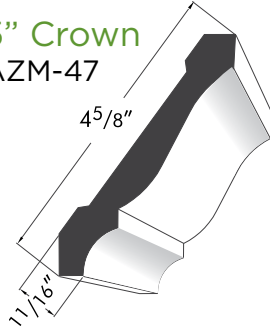

4" Crown
AZM-49

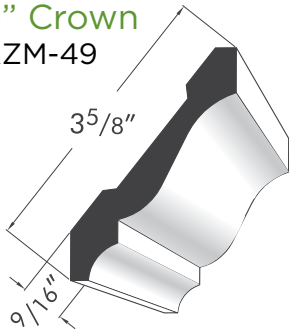

3" Crown
AZM-52

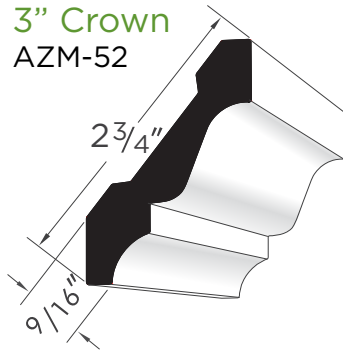

Rams Crown
AZM-6934

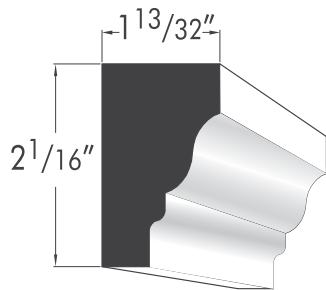

COVE PROFILES

Cove profiles are typically used along the intersection of a wall and ceiling.

Bed Moulding
AZM-75

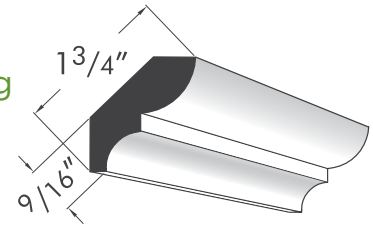

Scotia
AZM-93

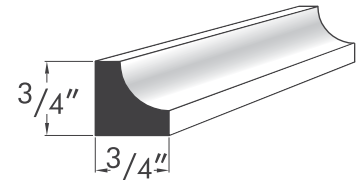

Quarter Round
AZM-105

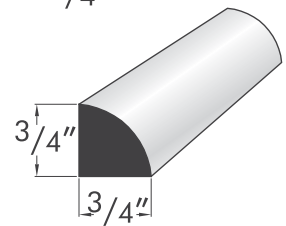

SHINGLE BAND PROFILES

Shingle Band is designed for use as a window or door casing or as a decorative shoe base.

Shingle Mould
AZM-210

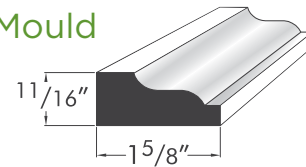

Band Moulding
AZM-217

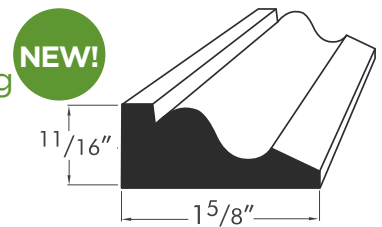

GARAGE DOOR THERMOSTOP

Popular moulding profile designed to seal new or existing garage door openings to minimize weather and moisture intrusion.

NEW!

Garage Door Thermostop
AZM-6936

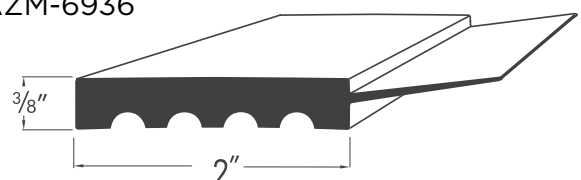

CASING PROFILES

Casing profiles are decorative mouldings typically used flush against a wall, door or window to create surrounds.

Rake Moulding

AZM-287

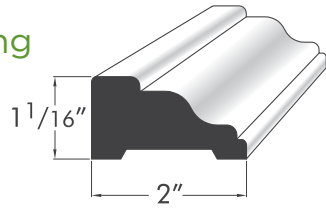

Adams Casing

AZM-97

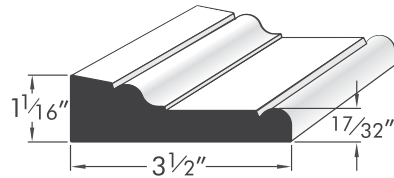

Brick Mould

AZM-180

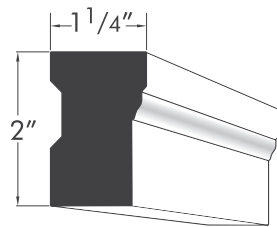

Back Band

AZM-6931

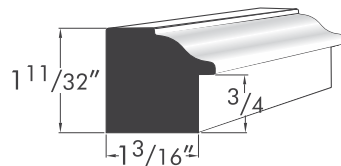

Base Cap

AZM-164

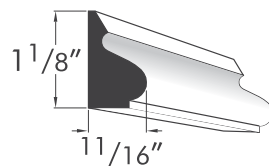

Square Profile

AZM-236

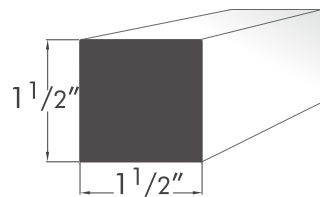

DRIP CAP PROFILES

Drip Cap is typically used as a water table or brick ledge for separation and water shed against two differing material types.

Drip Cap

AZM-197

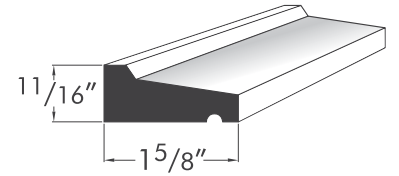

Water Table

AZM-6935

NEW!

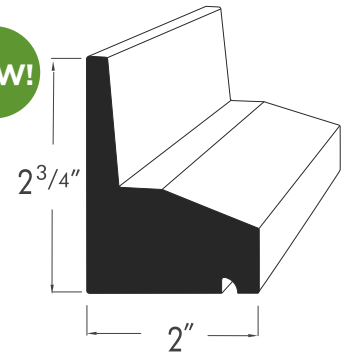

SILL PROFILES

Sill profiles shed water and offer architectural detail.

Historic Sill

AZM-6930

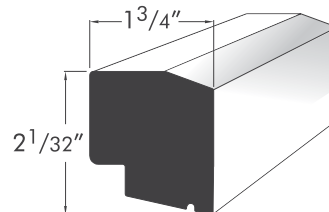

Sub Sill Nose

AZM-6933

